

Data Sheet

# Thermostatic expansion valve Type **T 2** and **TE 2**

Thermostatic expansion valves maintain a constant superheat level at the evaporator outlet

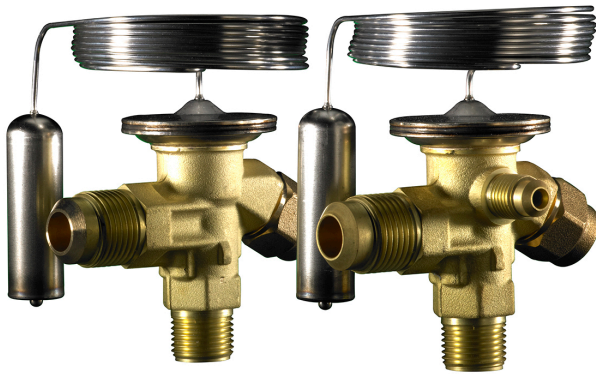

Thermostatic expansion valves regulate the injection of refrigerant liquid into evaporators.

Injection is controlled by the refrigerant superheat.

Therefore the valves are especially suitable for liquid injection in "dry" evaporators where the superheat at the evaporator outlet is proportional to the evaporator load.

## Features

- Large temperature range
  - Equally applicable to freezing, refrigeration and air conditioning applications.
- Interchangeable orifice assembly
  - easy storage
  - easy capacity matching
  - better service.
  - easy cleaning and replacement of filter
- Rated capacities from 1 to 20.5 kW / 0.3 to 5.8 TR for R407C
- Can be supplied with MOP (Max. Operating Pressure).
  - Protects the compressor motor against excessive evaporating pressure during normal operation
- Stainless steel bulb and Danfoss patented bulb strap
  - Fast and easy to install
  - Good temperature transfer from pipe to bulb
- Valves for special temperature ranges can be supplied
- Design protected

**Functions**

Figure 1: Functions

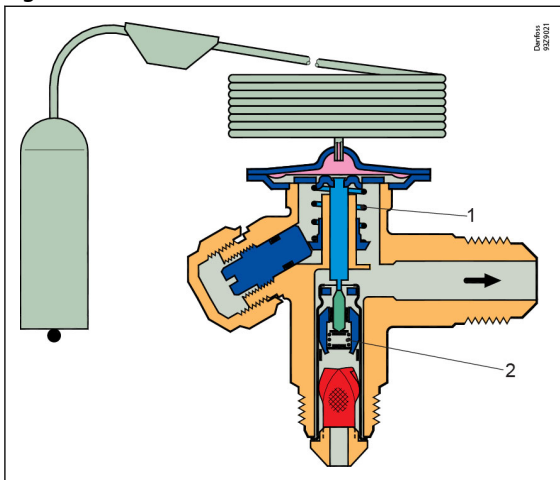

1	Element Spring
2	Orifice spring

T2 and TE2 valves have an interchangeable orifice assembly.

The orifice assembly is suitable for all versions of valve body and refrigerants and in all evaporating temperature ranges.

The charge in the thermostatic element depends on the refrigerant and evaporating temperature range.

The valves are available with internal (T2) or external (TE2) pressure equalization.

External pressure equalization should always be used on systems with liquid distributors. The bulb gives fast and precise reaction to temperature changes in the evaporator. The bulb is fixed with a Danfoss patented bulb strap for quick, easy and reliable connection. The valves are able to withstand the effects that normally occur with hot gas defrosting.

To ensure long operating life, the valve cone and seat are made of a special alloy with particularly good wear qualities.

## Product specification

### Technical data

#### Max. temperature

Bulb, when valve is installed: 100 °C

Bulb, element not mounted: 60 °C

#### Min. temperature

T2 – TE2: -60 °C

#### Max. test pressure

PT = 38 bar

#### Max. working pressure

PS/MWP = 34 bar

Table 1: Technical data

Refrigerant	Range N	Range NM	Range NL	Range B
	-40 °C – 10 °C	-40 °C – -5 °C	-40 °C – -15 °C	-60 °C – -25 °C
	MOP-point in evaporating temperature $t_e$ and evaporating pressure $p_e$ <sup>(1)</sup>			
	15 °C / 60 °F	0 °C / 32 °F	-10 °C / 15 °F	-20 °C / -4 °F
R22	100 psig / 6.9 bar (abs)	60 psig / 4.0 bar (abs)	35 psig / 2.4 bar (abs)	20 psig / 1.4 bar (abs)
R407C	95 psig / 6.6 bar (abs)	–	–	–
R134a	55 psig / 3.8 bar (abs)	30 psig / 2.0 bar (abs)	15 psig / 1.0 bar (abs)	–
R404A/R507	120 psig / 8.3 bar (abs)	75 psig / 5.2 bar (abs)	50 psig / 3.4 bar (abs)	30 psig / 2.1 bar (abs)

<sup>(1)</sup>  $p_e$  in bar gauge

#### Superheat

SS = static superheat

OS = opening superheat

SH = SS + OS = total superheat

$Q_{nom}$  = rated capacity

$Q_{max}$  = maximum capacity

Static superheat SS can be adjusted with setting spindle.

Standard superheat setting SS is 4K for all standard valves.

The opening superheat OS is 6 K from when opening begins to where the valve gives its rated capacity  $Q_{nom}$ .

#### Example

Static superheat SS = 5 K

Opening superheat OS = 6 K

Total superheat SH = 5 + 6 = 11 K

Table 2: Range N: -40 to 50 °F

Orifice no.	Rated capacity in tons (TR)											
	R22	R407C	R134a	R513A	R404A R507	R407A	R407F	R448A	R449A	R454C	R455A	R1234yf
0X	0.25	0.26	0.19	0.16	0.18	0.25	0.28	0.26	0.25	0.22	0.24	0.14
0	0.51	0.51	0.34	0.29	0.37	0.49	0.56	0.51	0.49	0.42	0.47	0.25
1	1	1	0.59	0.51	0.75	1	1.1	1	0.97	0.79	0.93	0.43
2	1.3	1.4	0.73	0.62	1	1.3	1.5	1.4	1.3	1	1.3	0.53
3	2.3	2.3	1.2	1	1.8	2.3	2.6	2.3	2.3	1.8	2.2	0.88
4	3.4	3.5	1.8	1.5	2.8	3.5	4.1	3.6	3.5	2.6	3.3	1.3
5	4.8	4.7	2.4	2	3.7	4.6	5.4	4.6	4.5	3.4	4.2	1.7
6	5.6	5.6	2.9	2.5	4.4	5.6	6.5	5.7	5.5	4.2	5.2	2.1

The rated capacity is based on:

Evaporating temperature  $t_e$  = 40 °F

Condensing temperature  $t_c$  = 100 °F

Refrigerant temperature ahead of valve  $t_l$  = 98 °F

## Thermostatic expansion valve, type T 2 and TE 2

**Table 3: Range N: -40 to 10 °C**

Orifice no.	Rated capacity in kW											
	R22	R407C	R134a	R513A	R404A R507	R407A	R407F	R448A	R449A	R454C	R455A	R1234yf
0X	0.9	0.92	0.68	0.58	0.64	0.88	1	0.9	0.88	0.77	0.86	0.49
0	1.8	1.8	1.2	1	1.3	1.7	2	1.8	1.7	1.5	1.7	0.87
1	3.5	3.5	2.1	1.8	2.6	3.4	3.9	3.5	3.4	2.8	3.3	1.5
2	4.7	4.8	2.6	2.2	3.7	4.7	5.4	4.8	4.6	3.6	4.4	1.8
3	8	8.1	4.3	3.7	6.3	8	9.2	8.1	7.9	6.2	7.6	3.1
4	12.1	12.4	6.4	5.4	9.9	12.4	14.3	12.6	12.1	9.3	11.5	4.6
5	16.7	16.5	8.4	6.9	13	16.3	19	16.3	15.7	11.8	14.7	5.9
6	19.7	19.7	10.1	8.6	15.5	19.6	22.9	19.8	19.1	14.8	18.3	7.3

The rated capacity is based on:

Evaporating temperature  $t_e = 4.4$  °C

Condensing temperature  $t_c = 38$  °C

Refrigerant temperature ahead of valve  $t_l = 37$  °C

### **Valve selection based on capacity calculation**

As for extended capacity calculations and valve selection based on capacities and refrigerants, please refer to Coolselector®2. Rated and extended capacities are calculated with the Coolselector®2 calculation engine to ARI standards with the ASEREP equations based on laboratory measurements of selected valves.

### **How to select a valve**

Example:

Refrigerant = R407C

Q (capacity) = 1.1kW

$T_{cond}$  (condensing temperature) = 25 °C

$T_{evap}$  (evaporator temperature) = -30 °C

$T_{sub}$  (subcooling temperature) = 2 K

$D_{pd}$  (distributer pressure drop) = 1 bar

Q (capacity) = 1.1kW

$f_{sub}$  (subcooling correction factor) = 0.98

$f_p$  (distribution correction factor) = 0.96

$$\frac{Q}{f_{sub} \times f_p} = \text{selected capacity}$$

$$\frac{1.1}{0.98 \times 0.96} = 1.17 \text{ kW}$$

The selection will be: TE2 orifice 00 (1.21 kW > 1.17 kW)

**Table 4: Capacity in kW, range N -40 °C to 10 °C. Opening superheat  $sh = 6$  K**

Valve type	Orifice no.	Cond. temp. [°C]	Evaporating [°C]			
			-40	-30	-20	-10
T2 / TE2	0X	25	0.76	0.83	0.88	0.9
T2 / TE2	00		0.99	1.21	1.42	1.6
T2 / TE2	1		1.41	1.8	2.27	2.77

**Table 5: Subcooling correction factor 'fsub'**

Subcooling [K]	2	4	10	15
Correction factor	0.98	1	1.07	1.12

## Thermostatic expansion valve, type T 2 and TE 2

**Table 6: Distributer correction factor 'fp' \***

Pressure drop [bar]		Evaporating [°C]			
		-40	-35	-30	-25
"Pressure drop [bar]"	0	1	1	1	1
	1	0.96	0.96	0.96	0.96
	1.5	0.94	0.94	0.94	0.94
	2	0.92	0.92	0.92	0.92

\* Calculated at 32 °C condensing temperature

### Dimensions and weights

**Figure 2: Flare × flare (All dimintions are in mm)**

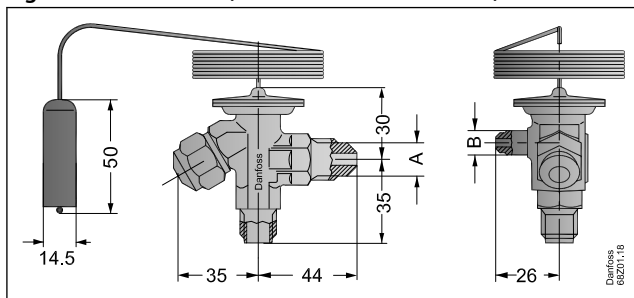

**Figure 3: Flare × solder (All dimintions are in mm)**

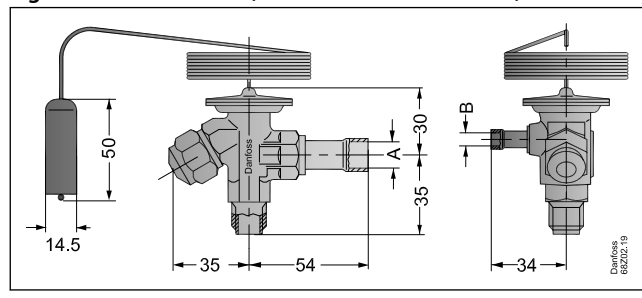

**Table 7: Dimensions and weights**

	Outlet	Equalization	Weight
	A	B	[kg / lb]
Flare × flare	1/2 " flare	1/4 " flare	0.3 / 0.7
Flare × solder	1/2 " solder 12 mm solder	1/4 " solder 6 mm solder	0.3 / 0.7

**Figure 4: Solder adaptor**

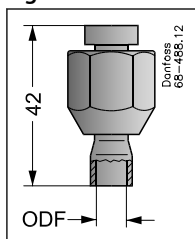
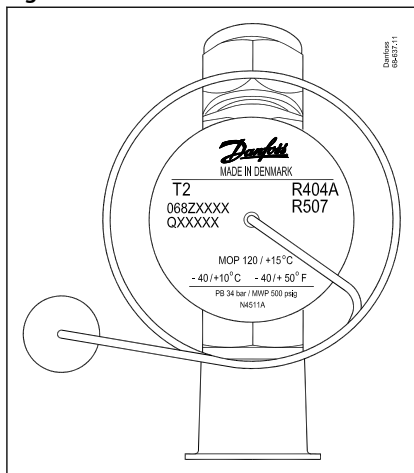

**Table 8: Solder adaptor**

Solder ODF		Weight
[in]	[mm]	[kg / lb]
1/4	6	0.05 / 0.11
3/8	10	0.05 / 0.11

## Identification

Figure 5: Identification



<b>T2</b>	internal equalization
<b>TE2</b>	external equalization
<b>N</b>	Nordborg, Denmark (BE = Wuqing, China)
<b>45</b>	week
<b>11</b>	2011
<b>A</b>	Monday

### Production place and date N4511A

The thermostatic element has laser engraved data on top of the diaphragm. This engraving gives valve type (with code number), evaporating temperature range, MOP point, refrigerant, and max. working pressure. PS/MWP.

Figure 6: Orifice assembly and filter for flare x flare version for T2 and TE2

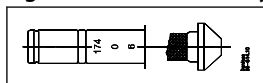

### Orifice assembly for T2 and TE2

The orifice assembly is marked with the orifice size (e.g. 06) and week stamp + last number in the year (e.g. 174). The orifice assembly number is also given on the lid of its plastic container.

Figure 7: Capillary tube label for T2 and TE2



### Capillary tube label for T2 and TE2

The label gives the orifice size (04) and consists of the lid of the orifice assembly plastic container. It can easily be fastened around the expansion valve capillary tube to clearly identify the valve size.

## Ordering

### T2/TE2 Thermostatic element with bulb strap

#### Flare x flare

Figure 8: Flare x flare

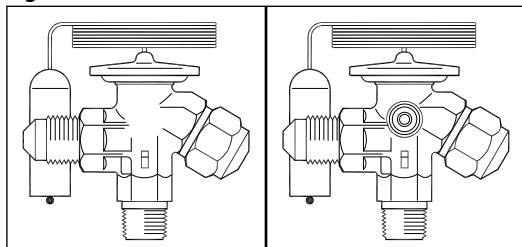

Capillary tube: 1.5 m

Range N = -40 – 10 °C

Range B = -60 – -25 °C

Range NM = -40 – -5 °C MOP 0 °C

Range NL = -40 – -15 °C MOP -10 °C

Table 9: Flare x flare

Refrigerant	Type	Range	MOP	Pressure equalization Flare	Connection flare inlet × outlet		Code no. Multi pack
		[°C]	[°C]		[in]	[mm]	
R22/R407C <sup>(1)</sup>	T2	-40 – 10	–	–	3/8 × 1/2	10×12	068Z3206
	T2	-40 – 10	15	–	3/8 × 1/2	10×12	068Z3208
	T2	-40 – -5	0	–	3/8 × 1/2	10×12	068Z3224
	T2	-40 – -15	-10	–	3/8 × 1/2	10×12	068Z3226
	T2	-60 – -25	–	–	3/8 × 1/2	10×12	068Z3207
	T2	-60 – -25	-20	–	3/8 × 1/2	10×12	068Z3228
	TE2	-40 – 10	–	¼ in / 6 mm	3/8 × 1/2	10×12	068Z3209
	TE2	-40 – 10	15	¼ in / 6 mm	3/8 × 1/2	10×12	068Z3211
	TE2	-40 – -5	0	¼ in / 6 mm	3/8 × 1/2	10×12	068Z3225
	TE2	-40 – -15	-10	¼ in / 6 mm	3/8 × 1/2	10×12	068Z3227
	TE2	-60 – -25	–	¼ in / 6 mm	3/8 × 1/2	10×12	068Z3210
R407C	TE2	-60 – -25	-20	¼ in / 6 mm	3/8 × 1/2	10×12	068Z3229
	T2	-40 – 10	–	–	3/8 × 1/2	10×12	068Z3496
	T2	-40 – 10	15	–	3/8 × 1/2	10×12	068Z3516
	TE2	-40 – 10	–	¼ in / 6 mm	3/8 × 1/2	10×12	068Z3501
R134a/R513A	TE2	-40 – 10	15	¼ in / 6 mm	3/8 × 1/2	10×12	068Z3517
	T2	-40 – 10	–	–	3/8 × 1/2	10×12	068Z3346
	T2	-40 – 10	15	–	3/8 × 1/2	10×12	068Z3347
	T2	-40 – -5	0	–	3/8 × 1/2	10×12	068Z3393
	T2	-40 – -15	-10	–	3/8 × 1/2	10×12	068Z3369
	TE2	-40 – 10	–	¼ in / 6 mm	3/8 × 1/2	10×12	068Z3348
	TE2	-40 – 10	15	¼ in / 6 mm	3/8 × 1/2	10×12	068Z3349
	TE2	-40 – -5	0	¼ in / 6 mm	3/8 × 1/2	10×12	068Z3392
TE2	-40 – -15	-10	¼ in / 6 mm	3/8 × 1/2	10×12	068Z3370	



## Thermostatic expansion valve, type T 2 and TE 2

Refrigerant	Type	Range	MOP	Pressure equalization Flare	Connection flare inlet × outlet		Code no. Multi pack
		[°C]	[°C]		[in]	[mm]	
R404A/R507	T2	-40 – 10	–	–	3/8 × 1/2	10×12	068Z3400
	T2	-40 – 10	15	–	3/8 × 1/2	10×12	068Z3402
	T2	-40 – -5	0	–	3/8 × 1/2	10×12	068Z3406
	T2	-40 – -15	-10	–	3/8 × 1/2	10×12	068Z3408
	T2	-60 – -25	–	–	3/8 × 1/2	10×12	068Z3401
	T2	-60 – -25	-20	–	3/8 × 1/2	10×12	068Z3410
	TE2	-40 – 10	–	1/4 in / 6 mm	3/8 × 1/2	10×12	068Z3403
	TE2	-40 – 10	15	1/4 in / 6 mm	3/8 × 1/2	10×12	068Z3405
	TE2	-40 – -5	0	1/4 in / 6 mm	3/8 × 1/2	10×12	068Z3407
	TE2	-40 – -15	-10	1/4 in / 6 mm	3/8 × 1/2	10×12	068Z3409
	TE2	-60 – -25	–	1/4 in / 6 mm	3/8 × 1/2	10×12	068Z3404
R407F/R407A	T2	-40 – 10	–	–	3/8 × 1/2	10×12	068Z3715
	TE2	-40 – 10	–	1/4 in / 6 mm	3/8 × 1/2	10×12	068Z3714
R448A/R449A	T2	-40 – 10	–	–	3/8 × 1/2	10×12	068Z3727
	TE2	-40 – 10	–	1/4 in / 6 mm	3/8 × 1/2	10×12	068Z3728
	T2	-40 – -15	-10	–	3/8 × 1/2	10×12	068Z3675
	T2	-60 – -25	-20	–	3/8 × 1/2	10×12	068Z3735
	TE2	-60 – -25	-20	1/4 in / 6 mm	3/8 × 1/2	10×12	068Z3736
R454C	T2	-40 – 10	-	–	3/8 × 1/2	10×12	068Z7483
	TE2	-40 – 10	-	1/4 in / 6 mm	3/8 × 1/2	10×12	068Z7485
R455A	T2	-40 – 10	-	–	3/8 × 1/2	10×12	068Z7496
	TE2	-40 – 10	-	1/4 in / 6 mm	3/8 × 1/2	10×12	068Z7499
R1234yf	T2	-40 – 10	-	–	3/8 × 1/2	10×12	068Z7487
	TE2	-40 – 10	-	1/4 in / 6 mm	3/8 × 1/2	10×12	068Z7489

<sup>(1)</sup> For R407C plants. Please select valves from the dedicated R407C program

### Flare x solder

Figure 9: Flare x solder

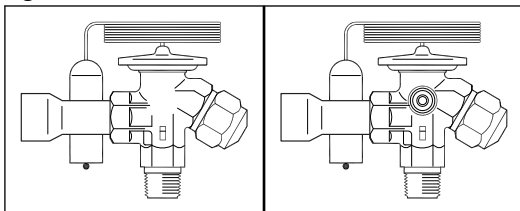

Capillary tube: 1.5 m  
 Range N = -40 – 10 °C  
 Range NL = -40 – -15 °C  
 Range B = -60 – -25 °C

## Thermostatic expansion valve, type T 2 and TE 2

Table 10: Flare x solder

Refrigerant	Type	Range	MOP	Pressure equaliza- tion Flare	Connection flare inlet x outlet		Code no. Multi pack
		[°C]	[°C]		[in]	[mm]	
R22/R407C <sup>(1)</sup>	T2	-40 – 10	–	–	3/8 x 1/2	–	068Z3281
	T2	-40 – 10	–	–	–	10x12	068Z3302
	T2	-40 – 10	15	–	3/8 x 1/2	–	068Z3287
	T2	-40 – 10	15	–	–	10x12	068Z3308
	T2	-40 – -15	-10	–	–	10x12	068Z3366
	T2	-60 – -25	–	–	3/8 x 1/2	–	068Z3357
	T2	-60 – -25	–	–	–	10x12	068Z3361
	T2	-60 – -25	-20	–	3/8 x 1/2	–	068Z3319
	TE2	-40 – 10	–	¼ in	3/8 x 1/2	–	068Z3284
	TE2	-40 – 10	–	6 mm	–	10x12	068Z3305
	TE2	-40 – 10	15	¼ in	3/8 x 1/2	–	068Z3290
	TE2	-40 – 10	15	6 mm	–	10x12	068Z3311
	TE2	-40 – -15	-10	6 mm	–	10x12	068Z3367
	TE2	-60 – -25	–	¼ in	3/8 x 1/2	–	068Z3359
	TE2	-60 – -25	–	6 mm	–	10x12	068Z3363
TE2	-60 – -25	-20	¼ in	3/8 x 1/2	–	068Z3320	
R407C	T2	-40 – 10	–	–	–	10x12	068Z3502
	T2	-40 – 10	15	–	3/8 x 1/2	–	068Z3329
	T2	-40 – 10	15	–	–	10x12	068Z3514
	TE2	-40 – 10	–	¼ in	3/8 x 1/2	–	068Z3446
	TE2	-40 – 10	–	6 mm	–	10x12	068Z3503
	TE2	-40 – 10	15	¼ in	3/8 x 1/2	–	068Z3447
	TE2	-40 – 10	15	6 mm	–	10x12	068Z3515
R134a/R513A	T2	-40 – 10	–	–	3/8 x 1/2	–	068Z3383
	T2	-40 – 10	–	–	–	10x12	068Z3384
	T2	-40 – 10	15	–	3/8 x 1/2	–	068Z3387
	T2	-40 – 10	15	–	–	10x12	068Z3388
	TE2	-40 – 10	–	¼ in	3/8 x 1/2	–	068Z3385
	TE2	-40 – 10	–	6 mm	–	10x12	068Z3386
	TE2	-40 – 10	15	¼ in	3/8 x 1/2	–	068Z3389
R404A/R507	TE2	-40 – 10	15	6 mm	–	10x12	068Z3390
	T2	-40 – 10	–	–	3/8 x 1/2	–	068Z3414
	T2	-40 – 10	–	–	–	10x12	068Z3435
	T2	-40 – 10	15	–	3/8 x 1/2	–	068Z3416
	T2	-40 – 10	15	–	–	10x12	068Z3423
	T2	-40 – -15	-10	–	3/8 x 1/2	–	068Z3429
	T2	-40 – -15	-10	–	–	10x12	068Z3436
	T2	-60 – -25	–	–	3/8 x 1/2	–	068Z3418
	T2	-60 – -25	–	–	–	10x12	068Z3425
	T2	-60 – -25	-20	–	3/8 x 1/2	–	068Z3420
	T2	-60 – -25	-20	–	–	10x12	068Z3427
	TE2	-40 – 10	–	¼ in	3/8 x 1/2	–	068Z3415
	TE2	-40 – 10	–	6 mm	–	10x12	068Z3422
	TE2	-40 – 10	15	6 mm	–	10x12	068Z3424
	TE2	-40 – 10	15	¼ in	3/8 x 1/2	–	068Z3417
	TE2	-40 – -15	-10	¼ in	3/8 x 1/2	–	068Z3430
	TE2	-40 – -15	-10	6 mm	–	10x12	068Z3437
	TE2	-60 – -25	–	¼ in	3/8 x 1/2	–	068Z3419
	TE2	-60 – -25	–	6 mm	–	10x12	068Z3426
	TE2	-60 – -25	-20	¼ in	3/8 x 1/2	–	068Z3421
TE2	-60 – -25	-20	6 mm	–	10x12	068Z3428	
R407F/R407A	T2	-40 – 10	–	–	3/8 x 1/2	–	068Z3716
	TE2	-40 – 10	–	¼ in	3/8 x 1/2	–	068Z3713

## Thermostatic expansion valve, type T 2 and TE 2

Refrigerant	Type	Range	MOP	Pressure equaliza- tion Flare	Connection flare inlet × outlet		Code no. Multi pack
		[°C]	[°C]		[in]	[mm]	
R448A/R449A	T2	-40 – 10	–	–	3/8 × 1/2	–	068Z3729
	TE2	-40 – 10	–	¼ in	3/8 × 1/2	–	068Z3730
	T2	-40 – -15	-10	–	3/8 × 1/2	–	068Z3664
	T2	-60 – -25	-20	–	3/8 × 1/2	–	068Z3737
	TE2	-40 – -15	-10	¼ in	3/8 × 1/2	–	068Z3665
	TE2	-60 – -25	-20	¼ in	3/8 × 1/2	–	068Z3738
	T2	-40 – -15	-10	–	–	10×12	068Z3674
	TE2	-60 – -25	-20	6 mm	–	10×12	068Z3672
R452A	T2	-40 – 10	–	–	3/8 × 1/2	–	068Z3806
	TE2	-40 – 10	–	¼ in	3/8 × 1/2	–	068Z3807
	T2	-40 – 10	–	–	–	10×12	068Z3808
	TE2	-40 – 10	–	6 mm	–	10×12	068Z3809
R454C	T2	-40 – 10	–	–	3/8 × 1/2	–	068Z7490
	T2	-40 – 10	–	–	–	10×12	068Z7484
	TE2	-40 – 10	–	¼ in	3/8 × 1/2	–	068Z7492
	TE2	-40 – 10	–	6 mm	–	10×12	068Z7486
R455A	T2	-40 – 10	–	–	3/8 × 1/2	–	068Z7494
	T2	-40 – 10	–	–	–	10×12	068Z7498
	TE2	-40 – 10	–	¼ in	3/8 × 1/2	–	068Z7501
	TE2	-40 – 10	–	6 mm	–	10×12	068Z7500
R1234yf	T2	-40 – 10	–	–	3/8 × 1/2	–	068Z7491
	T2	-40 – 10	–	–	–	10×12	068Z7488
	TE2	-40 – 10	–	¼ in	3/8 × 1/2	–	068Z7493
	TE2	-40 – 10	–	6 mm	–	10×12	068Z7495

<sup>(1)</sup> For R407C plants, please select valves from the dedicated R407C program

## Flare connections

Figure 10: Flare connections

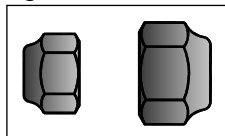

Table 11: Flare connections

Connection for copper tubing with outside diameter		Reducer for copper tubing with outside diameter		Code no.
[in]	[mm]	[in]	[mm]	
1/4	6	–	–	011L1101
3/8	10	–	–	011L1135
1/2	12	–	–	011L1103
–	–	1/4	6	011L1107

Example :

A TE2 thermostatic expansion valve consists of two parts + flare nuts if required:

- 1 thermostatic element
- 1 orifice assembly and flare nuts

When ordering one thermostatic expansion valve, TE2 with orifice 01, five code numbers are required:

- 1-off thermostatic element - 068Z3209
- 1-off orifice assembly 01 - 068-2010
- 1-off 3/8 in flare nut - 011L1135
- 1-off 1/2 in flare nut - 011L1103
- 1-off 1/4 in flare nut - 011L1101

### Orifice assembly with filter

Figure 11: Orifice assembly with filter

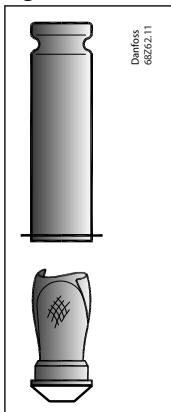

Table 12: Orifice assembly with filter

Orifice no.	Code no.
0X	068-2002
00	068-2003
01	068-2010
02	068-2015
03	068-2006
04	068-2007
05	068-2008
06	068-2009

### Orifice assembly with filter for solder adaptor

Figure 12: Orifice assembly with filter for solder adaptor

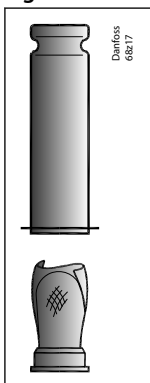

Table 13: Orifice assembly with filter for solder adaptor

Orifice no.	Code no.
0X	068-2089
00	068-2090
01	068-2091
02	068-2092
03	068-2093
04	068-2094
05	068-2095
06	068-2096

## Filter

Figure 13: Filter

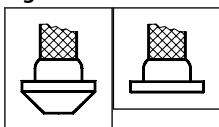
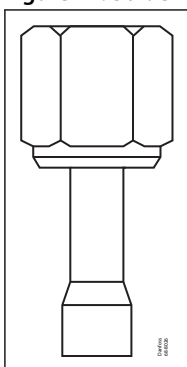

Table 14: Filter

Filter type	Code no. Multi pack
For flare connection	068-0003
For solder adaptor	068-0015

## Solder adaptor

Figure 14: Solder adaptor



The adaptor is for use with thermostatic expansion valves T2 and TE2 with flare × solder connections. When the adaptor is fitted correctly it meets the sealing requirements of DIN 8964.

The adaptor offers the following advantages:

- The orifice assembly can be replaced.
- The filter can be cleaned or replaced.

When using the solder adapter, a special orifice assembly is required. Please use the following tables to select both the appropriate adapter and orifice assembly.

Only in this way can the sealing requirements of DIN 8964 be fulfilled.

Solder adaptor for filter drier (FSA) must not be used in the T2 inlet.

Table 15: Solder adaptor without orifice assembly and filter

Connection ODF solder	Code no.
1/4 in	068-2062
6 mm	068-2063
3/8 in	068-2060
10 mm	068-2061

Table 16: Filter for solder adaptor

Description	Code no.
Filter excl. orifice assembly	068-0015

## Bulb strap (Danfoss patented)

Figure 15: Bulb strap

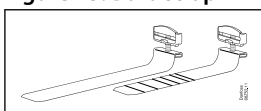

Each valve is delivered with a Danfoss patented bulb strap. Spares can be ordered.

## Thermostatic expansion valve, type T 2 and TE 2

---

**Table 17: Bulb strap (Danfoss patented)**

Description	Pack mode	Quantity / pack	Code no.
Accessory bag with short bulb strap I/45	I	45	068U3525
Accessory bag with long bulb strap I/45	I	45	068U3527
Accessory bag with short Bulb strap M/25	M	25	068U3520
Accessory bag with long Bulb strap M/45	M	45	068U3528

## Certificates, declarations, and approvals

The list contains all certificates, declarations, and approvals for this product type. Individual code number may have some or all of these approvals, and certain local approvals may not appear on the list.

Some approvals may change over time. You can check the most current status at [danfoss.com](https://danfoss.com) or contact your local Danfoss representative if you have any questions.

**Table 18: Certificates, declarations, and approvals**

File name	Document type	Document topic	Approval authority
EAC RU Д-ДК.БЛ08.В.00191_18	EAC Declaration	Machinery & Equipment	EAC
Danfoss 068U9615.06	Manufacturers Declaration	PED/RoHS	Danfoss
Danfoss 068Z9620.00	Manufacturers Declaration	-	Danfoss
Danfoss 068-9601.00	Manufacturers Declaration	-	Danfoss
UA.089.D.00188-17	UA Declaration	PED	LLC CDC EURO TYSK
UA.TR-089.0993-17	Pressure - Safety Certificate	PED	LLC CDC EURO TYSK
Danfoss 068U9616.01	Manufacturers Declaration	China RoHS	Danfoss

## Online support

Danfoss offers a wide range of support along with our products, including digital product information, software, mobile apps, and expert guidance. See the possibilities below.

### The Danfoss Product Store



The Danfoss Product Store is your one-stop shop for everything product related—no matter where you are in the world or what area of the cooling industry you work in. Get quick access to essential information like product specs, code numbers, technical documentation, certifications, accessories, and more.

Start browsing at [store.danfoss.com](https://store.danfoss.com).

### Find technical documentation



Find the technical documentation you need to get your project up and running. Get direct access to our official collection of data sheets, certificates and declarations, manuals and guides, 3D models and drawings, case stories, brochures, and much more.

Start searching now at [www.danfoss.com/en/service-and-support/documentation](https://www.danfoss.com/en/service-and-support/documentation).

### Danfoss Learning



Danfoss Learning is a free online learning platform. It features courses and materials specifically designed to help engineers, installers, service technicians, and wholesalers better understand the products, applications, industry topics, and trends that will help you do your job better.

Create your Danfoss Learning account for free at [www.danfoss.com/en/service-and-support/learning](https://www.danfoss.com/en/service-and-support/learning).

### Get local information and support



Local Danfoss websites are the main sources for help and information about our company and products. Find product availability, get the latest regional news, or connect with a nearby expert—all in your own language.

Find your local Danfoss website here: [www.danfoss.com/en/choose-region](https://www.danfoss.com/en/choose-region).

### Coolselector®2 - find the best components for you HVAC/R system



Coolselector®2 makes it easy for engineers, consultants, and designers to find and order the best components for refrigeration and air conditioning systems. Run calculations based on your operating conditions and then choose the best setup for your system design.

Download Coolselector®2 for free at [coolselector.danfoss.com](https://coolselector.danfoss.com).