

Data Sheet

Cartridge pressure switch
Type **ACB** and **CCB**

Fixed setpoints



Pressure controls ACB and CCB are compact disc type pressure switches with fixed set-points for long-standing use in refrigeration and air conditioning systems. They provide automatic or manual reset limit protection.

The small size, lightness and high degree of protection means that it can be mounted directly on the refrigeration systems.

The cartridge switch is available with different pressure settings and pressure connections to suit customer requirements.

All these features reduce installation costs and save space.

Features:

- Wide range
- Fixed pressure set points
- Automatic or manual reset
- Various port fittings for soldering or direct mounting
- Spades or cables
- Stripped ends or customer specific electrical plug
- Open or water-proof (IP65) version
- Type ACB for use as high and low pressure cut in and cut out as well as fan cycling
- Type CCB available for CO₂ refrigerants
- Compact design and easy to install

Applications

Air conditioning and refrigeration

Figure 1: Air conditioning and refrigeration

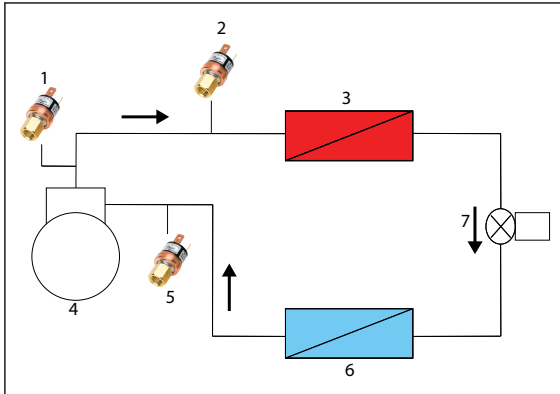

1	High Pressure
2	Fan Control
3	Condenser
4	Compressor
5	Low Pressure
6	Evaporator
7	Expansion valve

- Condenser fan switch
- Compressor stop – start
- Pump-down switch
- Low Pressure safety pressure switch
- High Pressure safety pressure switch

Product specification

Technical data

Table 1: Technical data

Type	ACB		CCB
	Water-proof (W)	Open – spade connector (O)	Water-proof (W)
Medium	R22, R134a, R404A, R407C, R407F, R410A, R438A, R448A, R449A, R452A, R513A. For flammable refrigerants please contact your nearest Danfoss office. For complete list of approved refrigerants, visit www.products.danfoss.com and search for individual code numbers, where refrigerants are listed as part of technical data		R744 (CO2)
Range	-0.5 – 45 bar / -7 – 652 psi		100 – 150 bar / 1450 – 2176 psi
Reset	Automatic, Manual		Automatic
Contact function	SPST-NO, SPST-NC, SPDT		SPST-NC
Electrical connections	AWG18 cables	Spades (size 6.35mm x 0.8 mm)	AWG18 cables
Cable length	150 cm (black)	-	150 cm (black)
Contact load variants	6 A @ 250 V AC for SPST		-
	4 A @ 250 V AC for SPDT		
	0,01 - 0,05 A @ 12/24 V DC		
Pressure connections	1/4 in ODM solder		6.35 mm solder
	6 mm ODM solder		
	1/4 in SAE female flare		
	with depressure pin		
Maximum working pressure PS / MWP	45 bar / 650 psi		165 bar / 2393 psi
Burst pressure	140 bar / 2030 psi		375 bar / 5440 psi
Media temperature	- 55 – 135 °C / -67 – 275 °F		- 30 – 100 °C / -20 – 210 °F
Ambient temperature	-30 – 85 °C / -20 – 185 °F		
Enclosure	IP65	No electrical protection	IP65

Customer specific features are available in a wide selection.

Lifetime

Switch type:

SPST auto reset, Normally open

Pressure setting : max 3 MPa

As general rule, ACB pressure switches are capable to cover applications requiring cycling from 100000 to 1500000 cycles dependent on current load. The exact number of cycles in any of given application is to be determined by appropriate testing.

Manufacturer reserves the right to change or modify specifications at any time without prior notice.

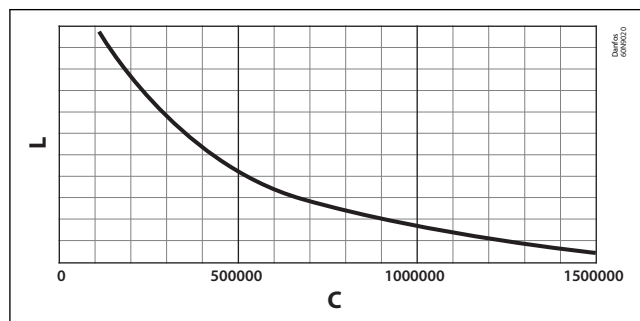

C	Number of cycles
L	Electrical load

SPST auto reset, Normally close – up to 100000 cycles

SPST manual reset, Normally close – 10000 cycles

SPDT auto reset – up to 100000 cycles

SPDT manual reset – 10000 cycles

Specification build up Type ACB

Field	Code	Explanation	Product	Electrical rating	Contact	Approvals	Enclosure	Reset	Housing	Port fitting	Upper activation setting [bar guage]	Tolerance on upper setting [bar]	Lower activation setting [bar guage]	Tolerance on low setting [bar]	Electrical connection	Cable length in cm	Cable plug	Mark if additional specifications	Details of special features (if any)
Requested specs:			Example: ACB 2U B 1 W A R L 20,0 1,0 15,0 1,5 A 100 0																
Product			ACB	2U	B	1	W	A	R	L	20,0	1,0	15,0	1,5	A	100	0		
Electrical rating	1U	1A @ 250V AC																	
	2U	6A @ 250V AC (SPST), 4A @ 250V AC (SPDT)																	
	4U	0,05A @ 12/24V DC (gold contacts)																	
Contact	A	SPST-NO																	
	B	SPST-NC																	
	C	SPDT																	
Approvals	0	CE [category II] approval																	
	1	CE [category II + IV], TÜV, VDE, UL & C-UL approvals (only with ACB)																	
	2	UL & C-UL approvals (only with ACB)																	
	3	CE [category II + IV] approval (only with ACB)																	
Enclosure	O	Open																	
	W	Waterproof IP65 (only with cables)																	
Reset	A	Automatic																	
	M	Manual (not SPST-NO; SPDT only in Panel mount housing)																	
Housing	R	Regular hot-melt																	
	E	Epoxy type																	
	P	Panel mount (mandatory for SPDT Manual reset versions)																	
Port fitting	M	1/4" SAE female flare w. deflator																	
	V	1/4" SAE female flare w. 1mm deflator																	
	H	1/4" SAE male flare																	
	P	1/4" solder Cu-tube (tip = 3 mm)																	
	X	1/4" solder Cu-tube (tip = 7 mm)																	
	S	1/4" solder Cu-tube (no tip)																	
	L	6 mm solder Cu-tube (tip = 7mm)																	
	E	1/8-27 NPT male																	
	Y	R (PT) 1/8"																	
Upper activation setting [bar guage]	---																		
Tolerance on upper setting [bar]	---																		
	---	+/- indicated value																	
Lower activation setting [bar guage]	---																		
Tolerance on low setting [bar]	---																		
	---	+/- indicated value																	
Electrical connection	A	AWG18 cables																	
	B	AWG16 cables																	
	C	AWG18 (UL 3173) cables																	
	S	90 deg. spades																	
	D	Double insulated AWG18 cables																	
	V	Double insulated H05VV5-F 2-in-1 cable (on request only, E housing only, Automatic reset only)																	
	R	Double insulated H05RNF 2-in-1 cable (on request only, E housing only, Automatic reset only)																	
	P	AWG18 with PVC tube																	
	H	AWG18 halogen free (RoHS compliant, currently E housing only)																	
Cable length in cm	---	Please use one of standard lengths: 020, 050, 080, 100, 150, 200 & 250 cm																	
Cable plug		(Leave blank if no cable)																	
	0	Cut ends																	
Faston	A	A1: AMP 170213-2, A2: AMP 170213-2, A3: OBR#250, A4: AMP 735222-2+AMP 735222-2, A5: AMP 170183-2, A6: AMP 170213-2																	
AMP	B	B1: AMP 350777-1, B2: AMP 282080-1, B3: AMP 282104-1, B4: AMP 192167-2, B5: AMP 881772-1, B6: AMP 174354-2																	
Molex	M	M1: 5557-02R																	
Pin connector	P	P1: Phoenix 3200250, P2: AMP 350218-1, P3: AMP 170213-2+AMP 926933-1, P4: AMP 926882-1, P5: AMP 165590-1																	
Packard	Q	Q1: 12010973, Q2: 12015792, Q3: 15300002, Q4: 15300027, Q5: 12020829																	
Stripped end	S	S1: stripped ends 15mm, S2: stripped ends 10mm																	
VHR	V	V1: VHR-2N, V2: VHR-3N																	
WAGO	W	W1: 231-302/026-000, W2: 769-102/021-000																	
Additional features																			
		Leave blank if no additional specifications																	
	X	Please specify (clear text attachment)																	
Details of special features (if any)																			

Electrical connections

Table 2: Electrical connections

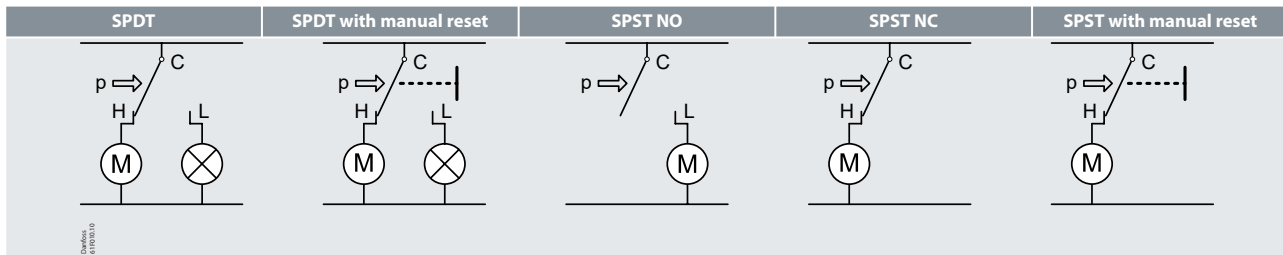

SPST - Single Pole Single Throw
 SPDT - Single Pole Double Throw
 (NO) - Normally Open
 (NC) - Normally Closed

Design

Figure 2: ACB - SPST manual reset

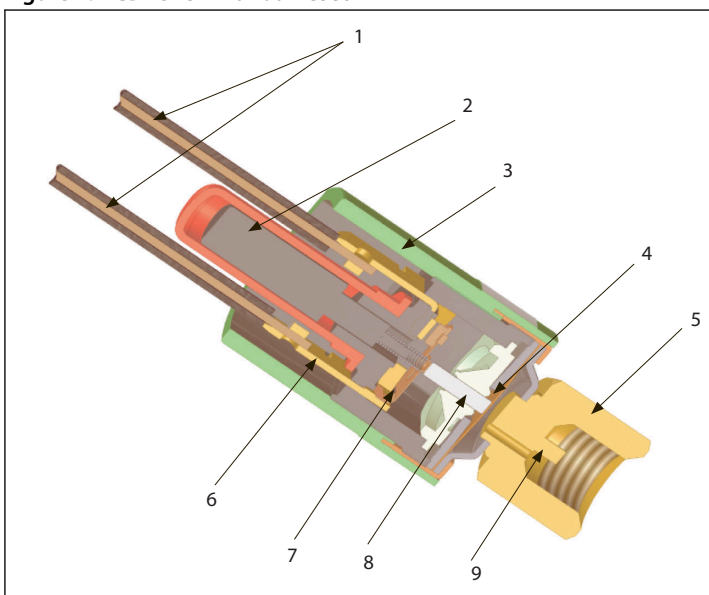

1	Wires
2	Reset button
3	Water-proof casing
4	Diaphragm
5	Pressure connection (1/4 in female flare)
6	Electrical terminals
7	Micro-switch
8	Shaft
9	Depressure pin

As pressure is applied through the connection on to the diaphragm, the diaphragm is pushed up against the operation shaft.

When the operation shaft rises, it pushes up the contact plate, so that contacts become connected (in normally open) or disconnected (in normally closed).

As the pressure in the connection decreases, the diaphragm returns to its original state, and the operation shaft lowers, causing the contact plate to return to its original position.

Dimensions [mm] and weights [kg]

Table 3: Type ACB – SPST water-proof

With automatic reset 1/4 in solder type	With automatic reset female flare
<p>Net weight: 0.072 kg</p>	<p>Net weight: 0.080 kg</p>

Table 4: Type ACB – SPST water-proof

With manual reset 6 mm solder type	With automatic reset 6 mm solder type
<p>Net weight: 0.078 kg</p>	<p>Net weight: 0.072 kg</p>

Cartridge pressure switch, type ACB and CCB

Table 5: Type ACB – SPDT

With automatic reset	With manual reset
<p>AWM HALOGEN FREE CABLE UL3266, AWG18, 125 °C, 300 V ($\lambda=1000\pm50$)</p> <p>Net weight: 0.114 kg</p>	<p>HEAT PROOF ELECTRIC VINYL WIRE UL1015, AWG18, 105 °C ($\lambda=1500\pm50$)</p> <p>Net weight: 0.112 kg</p>

Table 6: Type ACB – SPDT open type

Solder type	With female flare
<p>Net weight: 0.024 kg</p>	<p>Net weight: 0.029 kg</p>

Cartridge pressure switch, type ACB and CCB

Table 7: Type CCB - SPST water proof

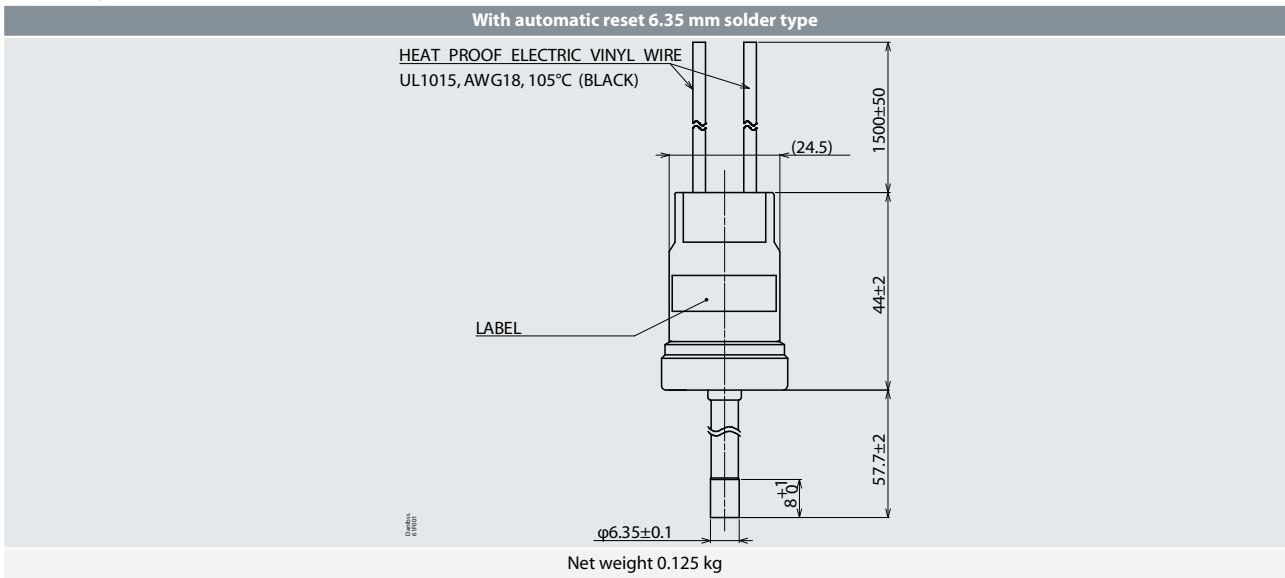

Ordering

Standard models

Type ACB

Table 8: High pressure cut out

Reset	Cut out	Cut in	Contact system / enclosure type W-water-proof types with cable (IP65) O-open (spade connector) types / no cable (IP00)	Connection type		
	[bar] [psi]	[bar] [psi]		Solder		Flare
				6 mm	¼ in	7/16-20 UNF with de-pressure pin
Auto.	18 ± 0.7 / 260 ± 10	13 ± 1.2 / 190 ± 17	SPST-NC / W	061F7504 ACB-2UB504W	061F7505 ACB-2UB505W	061F7506 ACB-2UB506W
			SPDT / W	-	-	061F9057 ACB-2UC59W
	20 ± 1 / 290 ± 14	16 ± 1.5 / 230 ± 21	SPST-NC / O	-	061F8710 ACB-2UB210	061F8708 ACB-2UB208
Auto.	23 ± 0.7 / 335 ± 10	19 ± 1.2 / 275 ± 17	SPST-NC / W	-	-	061F8494 ACB-2UB465W
			SPST-NC / O	-	061F8707 ACB-2UB207	061F8703 ACB-2UB203
			SPDT / W	-	-	061F9056 ACB-2UC58W
Man.				-	-	061F9243 ACB-2UC63MW
Auto.	26 ± 1 / 380 ± 15	20 ± 1.5 / 290 ± 22	SPST-NC / W	061F7507 ACB-2UB507W	061F7508 ACB-2UB508W	061F7509 ACB-2UB509W
			SPST-NC / O	-	061F8705 ACB-2UB205	061F8701 ACB-2UB201
Man.			SPST-NC / W	061F9703 ACB-2UB803MW	061F9714 ACB-2UB814MW	061F9713 ACB-2UB813MW
Auto.			SPDT / W	-	-	061F9055 ACB-2UC57W
Auto.	28 ± 1 / 405 ± 14	21 ± 1.5 / 305 ± 22	SPST-NC / W	061F7510 ACB-2UB510W	061F7513 ACB-2UB513W	061F7514 ACB-2UB514W
Man.				-	-	061F9522 ACB-2UB327MW
Auto.			SPST-NC / O	-	061F8704 ACB-2UB204	061F8700 ACB-2UB200
Auto.			SPDT / W	-	-	061F9054 ACB-2UC56W
Man.			SPDT / W	-	-	061F9242 ACB-2UC62MW
Auto.	31 ± 1 / 405 ± 14	24 ± 1.5 / 350 ± 22	SPST-NC / W	061F8493 ACB-2UB464W	-	061F8492 ACB-2UB463W
			SPST-NC / O	-	061F8706 ACB-2UB206	061F8702 ACB-2UB202
			SPDT / W	-	-	061F9053 ACB-2UC55W
Auto.	42 ± 1.2 / 610 ± 17	33 ± 2 / 480 ± 29	SPST-NC / W	061F7515 ACB-2UB515W	061F7516 ACB-2UB516W	061F7517 ACB-2UB517W
Man.				-	-	061F9575 ACB-2UB461MW
Auto.			SPDT / W	-	-	061F9052 ACB-2UC54W

NOTE:

Other code numbers are available upon request.

Cartridge pressure switch, type ACB and CCB

Table 9: Low pressure control

Reset	Cut out	Cut in	Contact system / enclosure type W-water-proof types with cable (IP65) O-open (spade connector) types / no cable (IP00)	Connection type		
	[bar] [psi]	[bar] [psi]		Solder		Flare
				6 mm	1/4 in	7/16-20 UNF with de-pressure pin
Auto.	0.5 ± 0.4 / 7 ± 6	1.5 ± 0.5 / 22 ± 4	SPST-NO / W	061F7518 ACB-2UA518W	061F7519 ACB-2UA519W	061F7520 ACB-2UA520W
			SPST-NO / O	-	061F7402 ACB-2UA152	061F7400 ACB-2UA150
			SPDT / O	-	061F9106 ACB-2UC106	061F9102 ACB-2UC102
Auto.	0.7 ± 0.5 / 10 ± 7	1.7 ± 0.4 / 25 ± 6	SPST-NO / W	061F7521 ACB-2UA521W	061F7522 ACB-2UA522W	061F7523 ACB-2UA523W
			SPDT / W	-	-	061F9058 ACB-2UC60W
Auto.	1.7 ± 0.5 / 25 ± 7	2.7 ± 0.4 / 39 ± 6	SPST-NO / W	061F7524 ACB-2UA524W	061F7525 ACB-2UA525W	061F7526 ACB-2UA526W
Auto.	2.2 ± 0.3 / 32 ± 4.5	3.4 ± 0.3 / 50 ± 4.5	SPST-NO / W	061F7418 ACB-2UA711W	-	-

Table 10: Fan control

Reset	Cut out	Cut in	Contact system / enclosure type W-water-proof types with cable (IP65) O-open (spade connector) types / no cable (IP00)	Connection type		
	[bar] [psi]	[bar] [psi]		Solder		Flare
				6 mm	1/4 in	7/16-20 UNF with de-pressure pin
Auto.	8.5 ± 1.2 / 125 ± 17	11 ± 0.8 / 160 ± 12	SPST-NO / W	061F8491 ACB-2UA393W	-	061F8490 ACB-2UA392W
	13 ± 1.5 / 190 ± 22	16 ± 1 / 230 ± 14		061F8334 ACB-2UA306W	-	061F8333 ACB-2UA305W

Type CCB

Figure 3: Type CCB

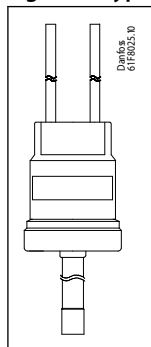
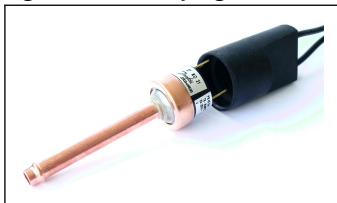

Table 11: High pressure control

Reset	Cut out	Cut in	Contact system / enclosure type W-water-proof types with cable (IP65)	Connection type	
	[bar] [psi]	[bar] [psi]		Solder 6.35 mm	
				Packing 100 pcs.	Packing 20 pcs.
Auto.	100±10 / 1450±145	70±20 / 1015±290	SPST-NC / W	061F9808 CCB-2UB03W	061F9908 CCB-2UB03W
	110±10 / 1595±145	80±20 / 1160±290		061F9809 CCB-2UB04W	061F9909 CCB-2UB04W
	120±10 / 1740±145	90±20 / 1305±290		061F9810 CCB-2UB05W	061F9910 CCB-2UB05W
	130±10 / 1885±145	100±20 / 1450±290		061F9811 CCB-2UB06W	-
	140±10 / 2030±145	100±20 / 1450±290		061F9812 CCB-2UB07W	-
	150±10 / 2175±145	100±20 / 1450±290		061F9813 CCB-2UB08W	-

Accessories

Figure 4: Rubber plug



A wide variety of cartridge switches are available with open enclosure - no electric protection. For these switches a water-proof rubber plug has been specially designed.

When the plug is installed on the switch a water-proof seal IP64 is obtained. The water-proof rubber plug is available with many different cable lengths.

Table 12: Accessories

Standard cable length [m] ⁽¹⁾	Packing quantity	Code no.
2.5	100	061F1302
6	100	061F1304

⁽¹⁾ Other cable lengths available upon request.

Certificates, declarations, and approvals

The list contains all certificates, declarations, and approvals for this product type. Individual code number may have some or all of these approvals, and certain local approvals may not appear on the list.

Some approvals may change over time. You can check the most current status at danfoss.com or contact your local Danfoss representative if you have any questions.

Table 13: Certificates, declarations, and approvals

File name	Document type	Document topic	Approval authority
UA.1O146.D.00075-19	UA Declaration	EMCD/LVD	LLC CDC EURO TYSK
Saginomiya 02-16	Manufacturers Declaration	China RoHS	Danfoss
RU Д-ДК.ГА02.В.03367	EAC Declaration	EMC	EAC
RU C-ДК.БЛ08.В.00063_18	Electrical - Safety Certificate	EMC/LVE	EAC
01 202 931 Q-04 0018	Quality - Assurance Certificate	PED	TÜV
01 202 973-B-17-0002	Pressure - Safety Certificate	-	TÜV

- CE according to EN 12263
- Low Voltage Directive 2014/35/EU
- UL recognized (type ACB only):
 - UL 873 and CSA C22.2 No. 24-93
 - UL 121201 and CSA C22/2 No.213-17 (for flammable refrigerants only)

Online support

Danfoss offers a wide range of support along with our products, including digital product information, software, mobile apps, and expert guidance. See the possibilities below.

The Danfoss Product Store



The Danfoss Product Store is your one-stop shop for everything product related—no matter where you are in the world or what area of the cooling industry you work in. Get quick access to essential information like product specs, code numbers, technical documentation, certifications, accessories, and more.

Start browsing at store.danfoss.com.

Find technical documentation



Find the technical documentation you need to get your project up and running. Get direct access to our official collection of data sheets, certificates and declarations, manuals and guides, 3D models and drawings, case stories, brochures, and much more.

Start searching now at www.danfoss.com/en/service-and-support/documentation.

Danfoss Learning



Danfoss Learning is a free online learning platform. It features courses and materials specifically designed to help engineers, installers, service technicians, and wholesalers better understand the products, applications, industry topics, and trends that will help you do your job better.

Create your Danfoss Learning account for free at www.danfoss.com/en/service-and-support/learning.

Get local information and support



Local Danfoss websites are the main sources for help and information about our company and products. Find product availability, get the latest regional news, or connect with a nearby expert—all in your own language.

Find your local Danfoss website here: www.danfoss.com/en/choose-region.

Coolselector®2 - find the best components for you HVAC/R system



Coolselector®2 makes it easy for engineers, consultants, and designers to find and order the best components for refrigeration and air conditioning systems. Run calculations based on your operating conditions and then choose the best setup for your system design.

Download Coolselector®2 for free at coolselector.danfoss.com.

Danfoss A/S

Climate Solutions • danfoss.com • +45 7488 2222

Any information, including, but not limited to information on selection of product, its application or use, product design, weight, dimensions, capacity or any other technical data in product manuals, catalogues descriptions, advertisements, etc. and whether made available in writing, orally, electronically, online or via download, shall be considered informative, and is only binding if and to the extent, explicit reference is made in a quotation or order confirmation. Danfoss cannot accept any responsibility for possible errors in catalogues, brochures, videos and other material. Danfoss reserves the right to alter its products without notice. This also applies to products ordered but not delivered provided that such alterations can be made without changes to form, fit or function of the product.

All trademarks in this material are property of Danfoss A/S or Danfoss group companies. Danfoss and the Danfoss logo are trademarks of Danfoss A/S. All rights reserved.