

Technical Datasheet



9700 Series Analogue Transmitter Submersible Hydrostatic Level Transmitters Model: 9790 - Flange Mounted



Key Features

- Two-wire 24 Vdc loop-powered
- 4 to 20 mA
- Accuracy $\pm 0.1\%$ of calibrated span
- Ranges up to 200 m / 656 ft. H₂O, and 10:1 rangeability
- Ceramic capacitive sensor
- Low maintenance
- Fully submersible IP68 / NEMA 6P
- Reverse polarity protection
- Dedicated marine version



Series Overview

The 9700 Series range of tank level transmitters from Delta-Mobrey provide an accurate level measurement solution where in-tank problems such as foaming, vapor layers, and temperature gradients makes difficult the use of other instrumentation. Each transmitter version gives a high performance, has good long term stability, and is virtually maintenance free. Ceramic Capacitive Sensor (CCS) provides a “flush” diaphragm, avoiding the risks of sensor clogging. The sensor works like a capacitor with electrode surfaces on the inside comprising one measuring and one reference capacitor. The surfaces of the capacitors are gold-plated and linked to ASIC electronics. These electronics generate a signal proportional to the applied pressure, which is sent to the 4–20 mA signal conditioner

Other products

Other products we can offer:

- MLT100 Smart Hart Displacer Level Transmitter
- DMSP900SH Hart Transmitters Ultrasonic Transmitters
- D45 SMART Level probe for pressurised tanks

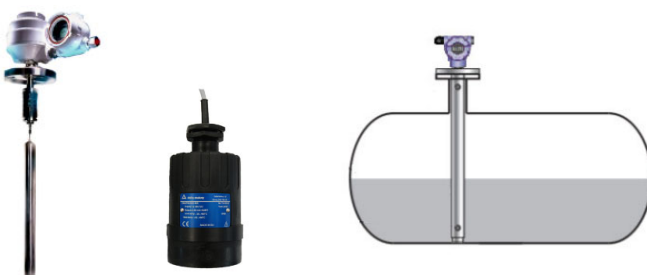

Product applications

The 9790 Transmitter is suitable for a wide range of applications in:

- Water Treatment
- Power
- Marine Market

The choice of models available ensures that the Delta Transmitter is suitable for use in:

- Corrosive atmospheres
- Resistant to chemical attack

How can we help you?

Delta Mobrey's offers fast, efficient and knowledgeable support when and where you need it. Please visit our website at www.delta-mobrey.com to find your local support centre or call us on:

+44 (0) 1252 729140

9700-Series
Model: 9790

How to order

Transmitters can be configured by selecting codes representing the desired features from the tables that follow. The chart below, describes how the model code is built up. For assistance in configuring a transmitter that best suits your needs, please contact your local sales office.

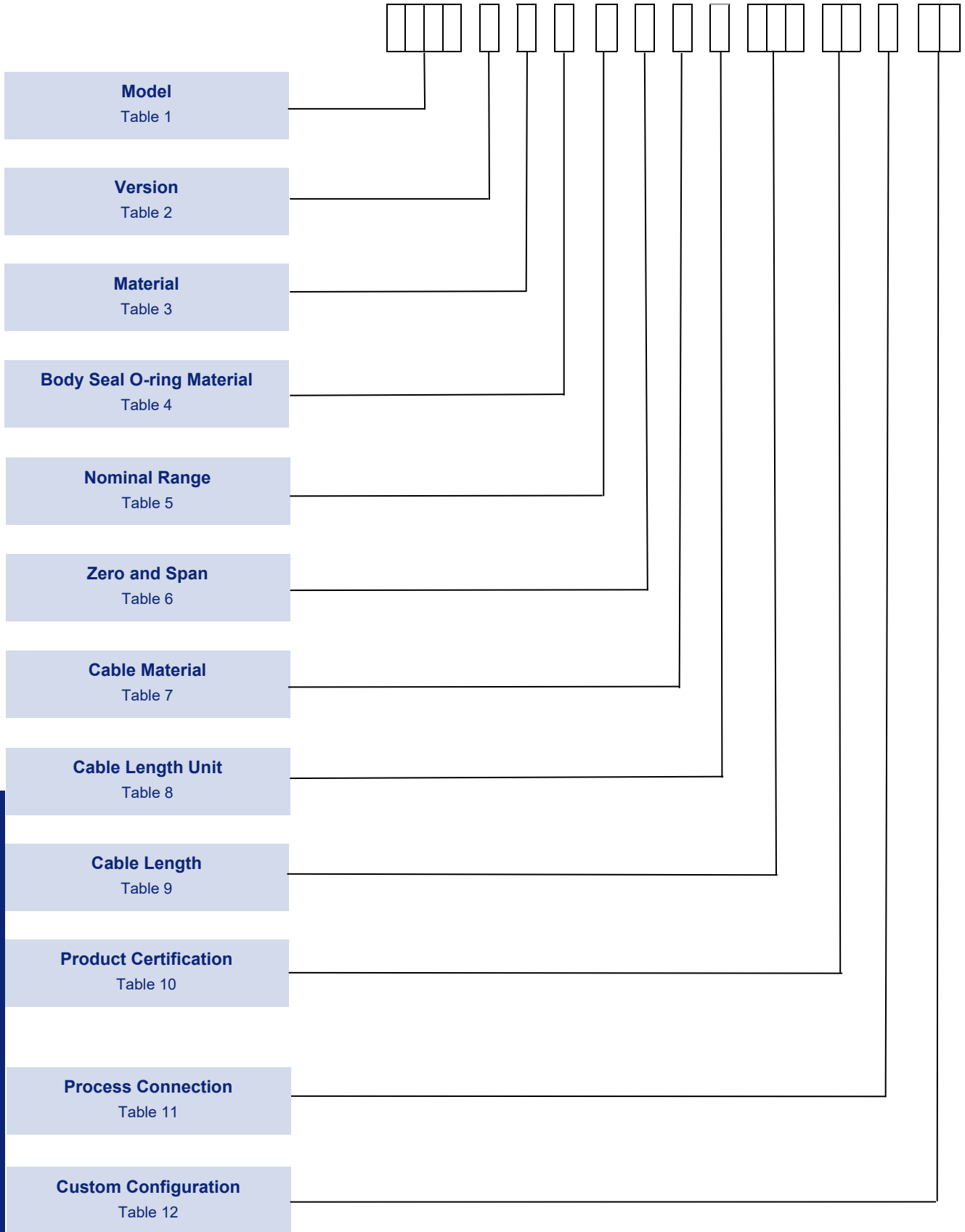

9700-Series
 Model: 9790

Model

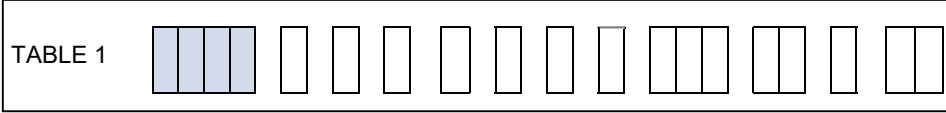

| | |
|--|-------------|
| | Code |
| Flange Mounted Submersible Hydrostatic Level Transmitter | 9790 |

Version

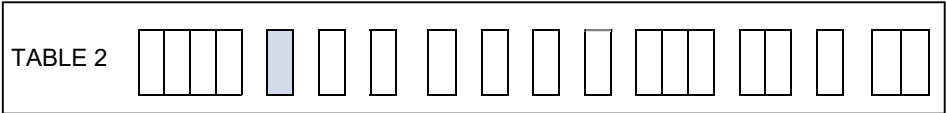

| | |
|-----------------|-------------|
| | Code |
| Commercial | C |
| Marine Approval | M |

Material

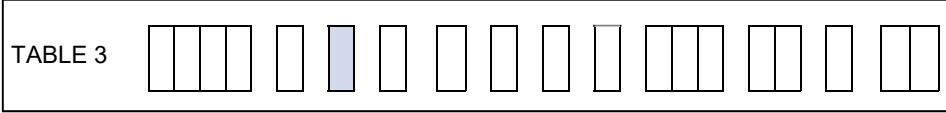

Note 1: purchaser's to verify the compatibility of material with process conditions (such as all chemical components, temperature, pressure, flow rate, abrasives, contaminants, etc.). Special construction to meet particular process conditions can be evaluated.

| | |
|---------------------|-------------|
| | Code |
| Stainless Steel 316 | S |
| Aluminum Bronze | A |

Note 2: The ceramic sensor is a "dry cell", meaning that no isolating diaphragm and fill fluid is needed. The process fluid acts directly onto the rugged, corro-

**Body Seal
O-ring Material**

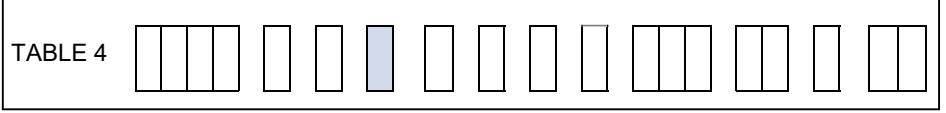

| | |
|------------------------|-------------|
| | Code |
| Fluorocarbon (FPM/FKM) | 1 |
| Nitrile | 2 |

9700 - Series
Model: 9790

Nominal Range

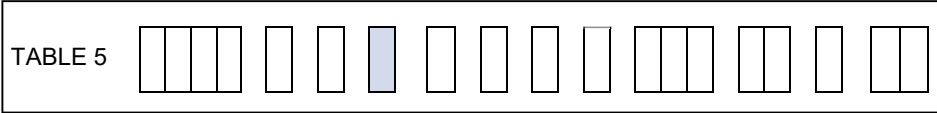

| | Code |
|--------------------------------------|----------|
| 0 to 6.5 ft. (0 to 2 m) H2O depth | A |
| 0 to 16.4 ft. (0 to 5 m) H2O depth | B |
| 0 to 32.8 ft. (0 to 10 m) H2O depth | C |
| 0 to 65.6 ft. (0 to 20 m) H2O depth | D |
| 0 to 164 ft. (0 to 50 m) H2O depth | E |
| 0 to 328 ft. (0 to 100 m) H2O depth | F |
| 0 to 3.3 ft. (0 to 1 m) H2O depth | G |
| 0 to 11.5 ft. (0 to 3.5 m) H2O depth | H |

Zero and Span

Note: the instrument is fixed range type. Any calibration within the measuring range to be specified at ordering stage.

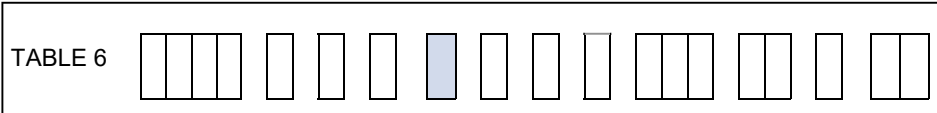

| | Code |
|------------------|----------|
| Integral (fixed) | 1 |

Cable Material

Note: The glanding system used ensures absolute integrity of the IP68 / NEMA 6P rating. All cable used include venting capillary. For humid environments or sea water applications, bellows must be used (contact Delta

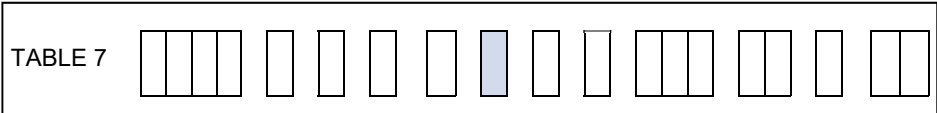

| | Code |
|---|----------|
| Polyurethane | P |
| Fluorinated ethylene-propylene (F.E.P) | F |

Cable Length Unit

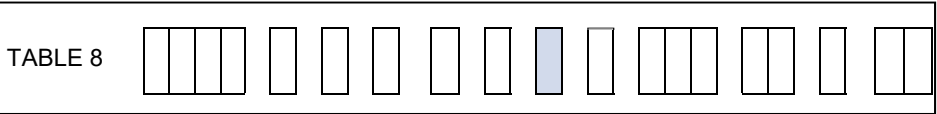

| | Code |
|---------|----------|
| English | E |
| Metric | M |

9700 - Series
Model: 9790

Cable Length

TABLE 9

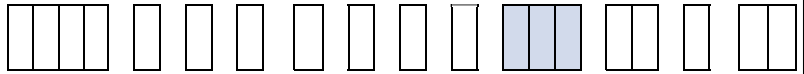

| Length | Code | Unit |
|-------------------|------|-------|
| 3 meters | 003 | M |
| 5 meters | 005 | M |
| 8 meters | 008 | M |
| 10 meters | 010 | M |
| 20 meters | 020 | M |
| 30 meters / feet | 030 | M / E |
| 40 meters | 040 | M |
| 50 meters | 050 | M |
| 60 meters | 060 | M |
| 75 meters | 075 | M |
| 100 meters | 100 | M |
| 125 meters | 125 | M |
| 150 meters / feet | 150 | M/E |
| 200 meters | 200 | M |
| 9 feet | 009 | E |
| 15 feet | 015 | E |
| 24 feet | 024 | E |
| 60 feet | 060 | E |
| 90 feet | 090 | E |
| 120 feet | 120 | E |
| 225 feet | 225 | E |
| 300 feet | 300 | E |
| 375 feet | 375 | E |
| 450 feet | 450 | E |
| 600 feet | 600 | E |

Product Certifications

TABLE 10

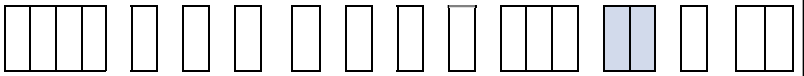

| | Code |
|---|------|
| Non-certified (non-hazardous area use only) | NA |
| CSA (Canada and USA) | A6 |

Process Connection

TABLE 11

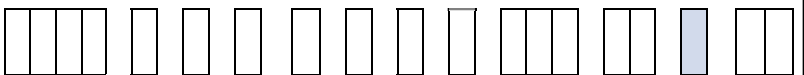

| | Code |
|--|------|
| Slip-on flange, DN25 PN40 (DIN 2635) | A |
| Fixed flange, DN40 PN40 (DIN 2635) | B |
| Fixed flange, DN50 PN40 (DIN 2635) | C |
| Fixed flange, DN80 PN40 (DIN 2635) | D |
| Slip-on flange, 1-in. ASME B16.5 Class 150 | E |
| Fixed flange, 2-in. ASME B16.5 Class 150 | F |
| Fixed flange, 3-in. ASME B16.5 Class 150 | |

9700-Series
Model: 9790

Custom Configuration

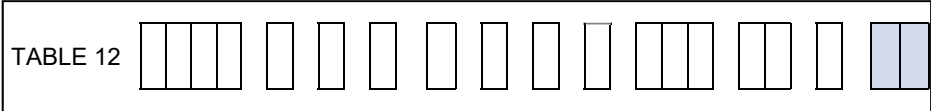

| | Code |
|---|------|
| Custom configuration of actual range (customer to specify with order) | C1 |

Installation

The 9700 is available in both submersible versions and externally mounted (floodable) versions. The housing contains the capacitive ceramic sensor and the electronics circuit board, all the components needed to produce an accurate and reliable measurement of the process. The glandng system used with the submersible versions ensures absolute integrity of the IP68 / NEMA 6P rating. IP68 / NEMA 6P units are generally factory fitted with the required length of vented cable fitted.

Technical Data

Metrological Parameters

| | |
|---------------------------|---|
| Accuracy | ±0.1% of calibrated span (includes effects of linearity, hysteresis and repeatability) |
| Stability | ± 0.1% Upper Range Limit (URL) per 6 months |
| Temperature Effect | ±0.015% Upper Range Limit (URL) per °C / °F (over ambient temp. range) |

Response time ~60mS (~10mS with link1 removed) or a 63% response to pressure change and 150mS for a 90% response to pressure change

Load resistance

$$R = 50 \times (\text{supply voltage} - 10V) \Omega \quad R [\Omega] \leq \frac{U_{\text{sup}} [V] - 10V}{0.0225A}$$

Materials

- Wetted parts** Sensor Ceramic
- Sensor housing** 316 Stainless steel, Aluminium bronze
- Seal rings** Fluorocarbon (FPM/FKM), Nitrile
- Cable** Polyurethane Fluorinated Ethylene Polypropylene (FEP)
- Ingress protection** IP68 / NEMA 6P (200 m / 656 ft. H20)

Electrical parameters

| | |
|----------------------|------------------|
| Power supply | 10-30V d.c. |
| Output signal | Two-wire, 4-20mA |

Operating conditions

Operating temperature range (ambient temp.)
-20 to + 90°C (-20 to +80°C Ex ia)

-Process medium temperature range
-20 to + 60 °C / -4 to +140 °F

Measuring range
Up to 200 m / 656 ft. H20

Overrange limit
5 x range up to a max 600 m / 1968 ft. H20

Span adjustment
+10 to +100% of Upper Range Limit (URL)

Mounting Option

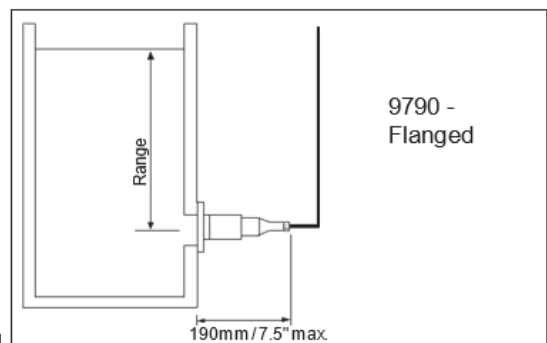

Electrical diagrams

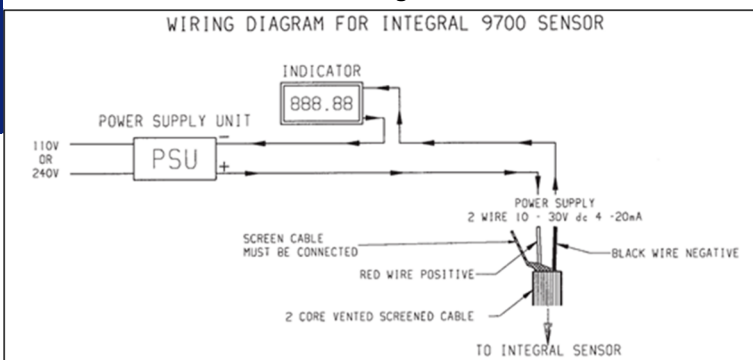

9700-Series
Model: 9790

Approvals

NORTH AMERICA CERTIFICATION



Hazardous area certification (CSA Nr.176418)

CSA (Canada and USA) CL I, Div 1, Groups C and D
 CL II, Div 1, Groups E, F and G
 CL III
 Ex ia IIB T4
 AEx ia IIB T4



EUROPEAN DIRECTIVE

EMC Directive 2014/30/EU

Conformity assessment procedure: module A

The following standards were applied: EN 61326-1:2013; EN61326-2-3:2013

Marine approvals

Lloyds Register Certificate Nr. 98/00014
 BV Certificate Nr. 07173/E0 BV
 DNV Certificate Nr. TAA000002H

Dimensions

| FLANGE TYPE | DIMN A | DIMN B | DIMN C | DIMN D | DIMN E |
|--------------------------|--------|-----------|-----------|--------|--------|
| DN40 PN40 DIN2635 | Ø150.0 | 110.0 PCD | 4 X Ø18.0 | Ø88.0 | 18.0 |
| DN50 PN40 DIN2635 | Ø165.0 | 125.0 PCD | 4 X Ø18.0 | Ø102.0 | 20.0 |
| DN80 PN40 DIN2635 | Ø200.0 | 160.0 PCD | 8 X Ø18.0 | Ø138.0 | 24.0 |
| 2" ANSI B16.5 CLASS 150B | Ø152.0 | 120.6 PCD | 4 x Ø19.0 | Ø92.0 | 19.0 |
| 3" ANSI B16.5 CLASS 150B | Ø190.0 | 152.4 PCD | 4 x Ø19.0 | Ø127.0 | 24.0 |

WEIGHT

| Model | Weight |
|--|-------------------|
| 9710 (sensor only) | 0.7 kg / 1.54 lbs |
| Bellows Enclosure Polyester (p/n 71411/773) IP67 Grey (RAL 7001) | 1.2 kg |
| Enclosure Polyester (p/n 9710/077/01) Grey | 0.7 kg |
| Vented Cable in air (water) | 71 (16) kg/km |

Total weight varies with different cable length

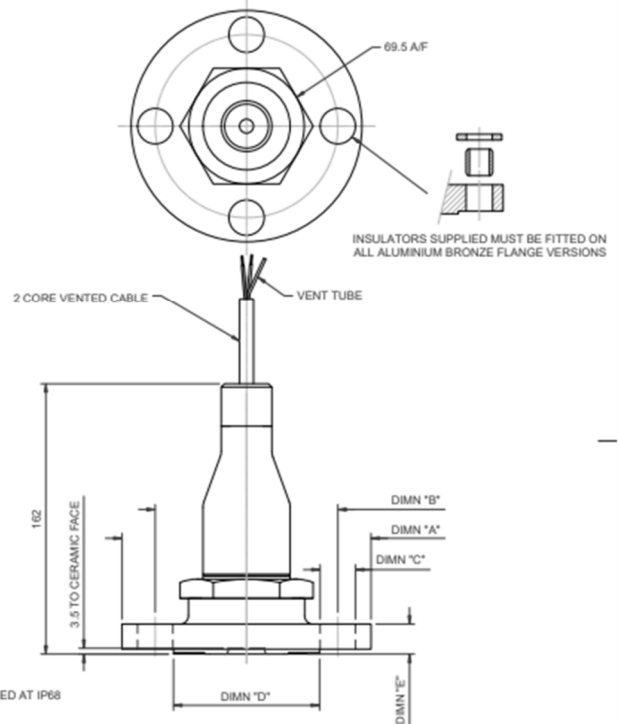

In the interest of development and improvement Delta Mobrey Ltd, reserves the right to amend, without notice, details contained in this publication. No legal liability will be accepted by Delta Mobrey Ltd for any errors, omissions or amendments.

Delta Mobrey Limited



9700-Series
 Model: 9790